

A New Static Traffic Assignment Using Density Based Travel Time

Pushkin Kachroo^{a,1,*}, Lillian Ratliff^b, Shankar Sastry^b

^a *Department of Electrical Engineering and Computer Engineering, University of Nevada, Las Vegas 4505 S. Maryland Pkwy Las Vegas, NV 89154*

^b *Department of Electrical Engineering and Computer Science, University of California Berkeley, Berkeley, CA 94704*

Abstract

This paper reviews the classic traffic assignment framework and then shows the inconsistency and ill-posedness of the travel time functions used for that even for a single arc. The paper then presents a density based travel time function that does not have this illposedness for a single arc. The classic steady state traffic assignment is cast using this new travel time function and corresponding mathematical programming formulations are proposed. It is shown that the modified Beckman formulation based on the density based travel time function provides a unique solution for arc flows and arc densities where the Wardrop condition has non unique values for arc traffic densities.

Keywords: Traffic assignment, travel time, Beckman, Traffic density, User Equilibrium, System Optimal

1. Introduction

Transportation systems are characterized by the two main aspects: safety and throughput. From the throughput aspect, travel time in transportation networks is the most important performance index of the system operation. The aim of most transportation systems is to provide a safe, comfortable minimum transit time between any two points (nodes) of the network. An exception might be the case when a user is driving, for instance, for purely as a recreational activity, and would like to travel slow while watching the surrounding scenery.

Travel time is used in many design and operations problems in transportation. For instance, it is used to perform traffic assignment ([3]), whether that is static assignment ([24]) or dynamic traffic assignment ([18]). Feedback control based dynaic traffic assignment is also based on travel time ([13],[22],[15],[16],[14]).

*Corresponding author

Email addresses: pushkin.kachroo@gmail.com (Pushkin Kachroo),
ratliff@eecs.berkeley.edu (Lillian Ratliff), sastry@coe.berkeley.edu (Shankar Sastry)

¹Visiting Professor at U.C.Berkeley

Travel time is an essential element of transportation planning models ([1],[8]). Similarly, it is used to develop performance measures for before and after events studies. It is also used to monitor the performance of the system in real time, as well as for aggregate performance over a time period for decision making and policy considerations.

Various methods of travel time data collection are presented in a Federal Highway (FHWA) report ([26]). Travel time prediction has been studied by many researchers and is extremely useful in many applications([2], [19], [7]).

The original travel time paper developing the travel time model based on the traffic fundamental diagram is [17]. That model was polished and a partial differential equation for travel time dynamics was presented in [18]. This paper presents the the static traffic assignment problem framed using this density based travel time function. By using the density based travel time function we are able to use the macroscopic traffic flow theory and also connect it to microscopic theory since we use the speed of a vehicle as the travel time function. Hence this new framework provides a unification of the traffic theory for traffic assignment problem.

Outline. The remainder of this paper is organized as follows. We review the travel time function used in practice in Section 2, where in Subsection 2.1 we show its application in static traffic assignment. Section 3 develops the formula for travel time delay at signalized intersections using queuing theory. Finally section 4 provides the formulation of the static assignment problems as mathematical programming problems and provides analysis of those models.

2. Static Travel Time Function and its Uses

The static travel time function $T(f)$ is a function of traffic flow f (also called traffic volume) on the link and the link capacity C . Capacity is defined as the traffic flow at traffic density whose value is half of the traffic jam density. Traffic jam density is the traffic density at which the vehicle speed is zero. It is also called maximum density. The static travel time function $T(f)$ is given by Equation 1

$$T(f) = t_f \phi \left(\frac{f}{C} \right) \tag{1}$$

where t_f is the freeflow travel time of a vehicle on the link, i.e. the time taken by a vehicle to traverse the link when traffic density on the link is zero.

The formula Bureau of Public Roads (BPR) gives uses a specific function $\phi(\cdot)$. Their model is given by the Equation 2

$$T(f) = t_f \left(1 + \beta \left(\frac{f}{C} \right)^\alpha \right) \tag{2}$$

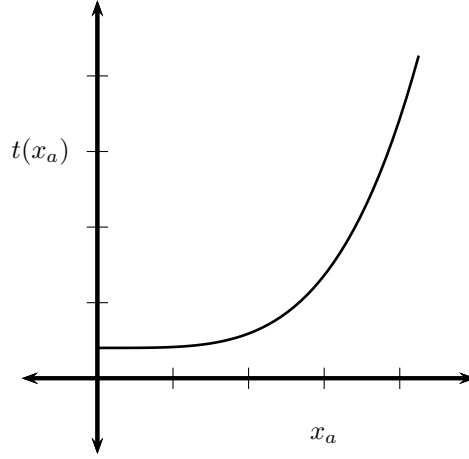

Figure 1: BPR Link Performance Function

where there are two parameters β usually taken as 1, and β whose value usually ranges from 2 to 12 in practice. The plot of the BPR function is shown in Figure 1

General properties that a travel time function on a link should satisfy in this formulation are presented in [25]. Some of these are:

- **Continuous Upto Second Differentiability:** $T(\cdot) \in C^2$
- **Positivity:** $\forall f \geq 0, T(f) \geq 0$
- **Monotonicity:** $f_1 \geq f_2 \Rightarrow T(f_1) \geq T(f_2)$
- **Strict Monotonicity of Slope:** $f'' > 0$
- **Boundedness of Slope:** $\exists M > 0, f' \leq M$
- **Uniqueness of Link Volume:** $f'(0) > 0$

Many travel time functions have been proposed that satisfy some or all of these requirements ([25],[4], [12])

2.1. Traffic Assignment

To build the mathematical framework for this section, we will start with terminology and framework used in [24]. We illustrate a sample network that is also taken from [24] and is shown in Figure 2. The digraph shows four nodes and four arcs. Nodes 1 and 2 are origin nodes and node 4 is the destination node. Hence there are two O-D pairs: 1 – 4 and 2 – 4.

There are two main classical traffic assignment optimization problems considered. Those two are: user-equilibrium, and system optimum.

Table 1: Network Notation

| | |
|---------------------|--|
| \mathfrak{N} | Set of Nodes |
| \mathfrak{A} | Set of Arcs |
| \mathfrak{R} | Set of Origin Nodes |
| \mathfrak{S} | Set of Destination Nodes |
| \mathfrak{K} | Set of Paths connecting O-D pair $r - s$, $r \in \mathfrak{R}$, $s \in \mathfrak{S}$ |
| x_a | Flow on arc $a \in \mathfrak{A}$ |
| t_a | Travel time on arc $a \in \mathfrak{A}$ |
| f_k^{rs} | Flow on path $k \in \mathfrak{K}$ between O-D pair $r - s$ |
| c_k^{rs} | Travel time on path $k \in \mathfrak{K}$ between O-D pair $r - s$ |
| f_{rs} | O-D Trip rate between O-D pair $r - s$ |
| $\delta_{a,k}^{rs}$ | $\delta_{a,k}^{rs} = 1$, if a is in path k between r and s , otherwise 0 |

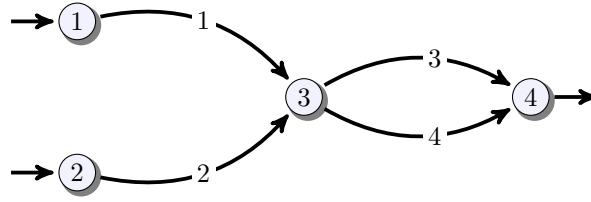

Figure 2: Sample Network

2.1.1. User-equilibrium

User-equilibrium problem is based on Wardrop's principle [28] which is stated as:

The journey times on all the routes actually used are equal, and less than those which would be experienced by a single vehicle on any unused route.

This equilibrium condition can be obtained as a solution of a mathematical programming problem presented below [24].

Mathematical Programming Formulation. The user equilibrium problem is stated as the mathematical programming problem (see [24], [5]) shown in Equation 3.

$$\min z(x) = \sum_a \int_0^{x_a} t_a(\omega) d\omega \quad (3)$$

with the equality constraints:

$$\sum_k f_k^{rs} = f_{rs} \quad \forall r, s \quad (4)$$

$$x_a = \sum_r \sum_s \sum_k f_k^{rs} \delta_{a,k}^{rs} \quad (5)$$

and the inequality constraint

$$f_k^{rs} \geq 0 \forall r, s \quad (6)$$

The formulation given in Equation 3 is the Beckmann transformation [3]. The link performance function $t_a(x_a)$ is a function of traffic flow on the link and the link capacity c_a . According to the Bureau of Public Roads (BPR) it is given by Equation 7

$$t_a(x_a) = v_f \left(1 + 0.15 \left(\frac{x_a}{c_a} \right)^4 \right) \quad (7)$$

2.1.2. System Optimal Solution

System optimal solution is a solution that provides the total minimum time for the entire network. This condition can be obtained as a solution of a mathematical programming problem presented below [24].

Mathematical Programming Formulation. The system optimal problem is stated as the mathematical programming problem (see [24], [5]) shown in Equation 8.

$$\min z(x) = \sum_a x_a t_a(x_a) \quad (8)$$

with the equality constraints:

$$\sum_k f_k^{rs} = f_{rs} \forall r, s \quad (9)$$

$$x_a = \sum_r \sum_s \sum_k f_k^{rs} \delta_{a,k}^{rs} \quad (10)$$

and the inequality constraint

$$f_k^{rs} \geq 0 \forall r, s \quad (11)$$

2.2. Limitations of the Static Travel Time Functions

In order to study the limitations of the static travel time functions, we will first present the traffic fundamental diagram and relationships, which will be the foundation for developing the theory of travel time dynamics. There are many different models that related the traffic density ρ f to the traffic flow (or flux or volume) which is the product of traffic density and the traffic speed v , i.e. $f = \rho v$. Some models use linear relationship (Greenshield's model, [10]), logarithmic relationship (Greenberg model, [9]), exponential relationship (Underwood model, [27]), piecewise linear relationship (cell transmission model, [6]),

and many others, such as Northwestern University model, Drew model, Pipes-Munjaj model, and multi-regime models. However, because of its mathematical simplicity we will use the Greenshield's model for developing the theory. The theory can be modified if we choose any other relationship.

2.2.1. Fundamental Diagram

Greenshield's model (see [10]) uses a linear relationship between traffic density and traffic speed.

$$v(\rho) = v_f \left(1 - \frac{\rho}{\rho_m}\right) \quad (12)$$

where v_f is the free flow speed and ρ_m is the maximum density. Free flow speed is the speed of traffic when the density is zero. This is the maximum speed. The maximum density is the density at which there is a traffic jam and the speed is equal to zero.

The traffic flow is the product of traffic density and speed and becomes

$$f(\rho) = v_f \rho \left(1 - \frac{\rho}{\rho_m}\right) \quad (13)$$

The traffic flow function (of density) is concave as can be confirmed by noting the negative sign of the second derivative of flow with respect to density, i.e. $\partial^2 f / \partial \rho^2 < 0$. The fundamental diagram refers to the relationship that the traffic density ρ , traffic speed v and traffic flow f have with each other. These relationships are shown in Figure 3.

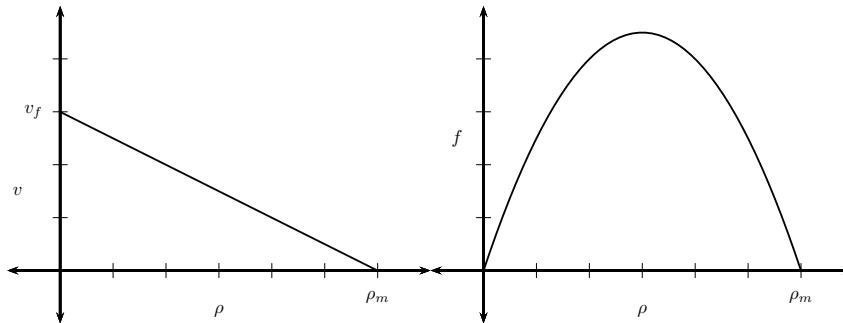

Figure 3: Fundamental Diagram using Greenshield Model

2.2.2. Travel Time based on the Fundamental Diagram

To study the fundamentals of travel time, let us take a single highway stretch as shown in Figure 4. The length of the stretch is ℓ . We show the two ends of the stretch as n_1 and n_2 , and the traffic density is a function of time t and (one dimensional) space x , so that we show density as $\rho(t, x)$. In steady state conditions, the traffic conditions don't change over time. Moreover, let us assume that the density is same over the entire section. Let's call this fixed value of density ρ_0 .

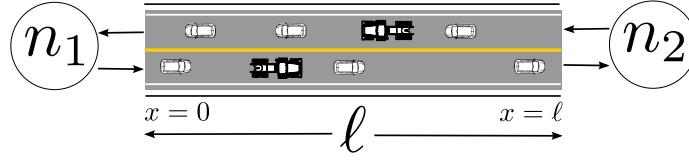

Figure 4: Travel Time over a Highway Section

The speed anywhere in this section will be constant, as it is given by the formula

$$v(\rho) = v_f \left(1 - \frac{\rho_0}{\rho_m}\right) \quad (14)$$

Hence, the travel time over the link which should be the distance of the link divided by the speed, is given by

$$T = \frac{\ell}{v_f \left(1 - \frac{\rho_0}{\rho_m}\right)} \quad (15)$$

Notice that the capacity of a link was given by the traffic flow corresponding to the maximum (or jam) density. Hence, for the linear model we have chosen, the capacity turns out to be maximum flow given by:

$$C = \frac{1}{4} v_f \rho_m \quad (16)$$

This travel time function is a function of the speed as compared to the other functions that were functions of traffic flow. The plot of this travel time function is shown in Figure 5.

The highway stretch is in equilibrium (steady state). The flow into the highway from node n_1 is equal to the flow out from the section to the node n_2 , and is given by:

$$f = v_f \rho_0 \left(1 - \frac{\rho_0}{\rho_m}\right) \quad (17)$$

Now, let us say, just like in traffic assignment problems where the travel time functions of traffic flow are used, that we are given a steady state traffic flow in

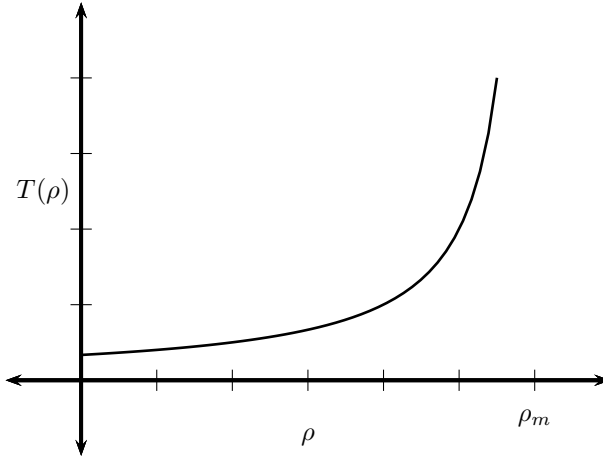

Figure 5: Travel Time Function based on Density

going from n_1 to n_2 that equals f_0 . For this given traffic flow, there will be two possible densities that produce the same flow. For this given flow, let us name the two densities $\rho_{\ell 0}$ and $\rho_{r 0}$ as shown in Figure 6.

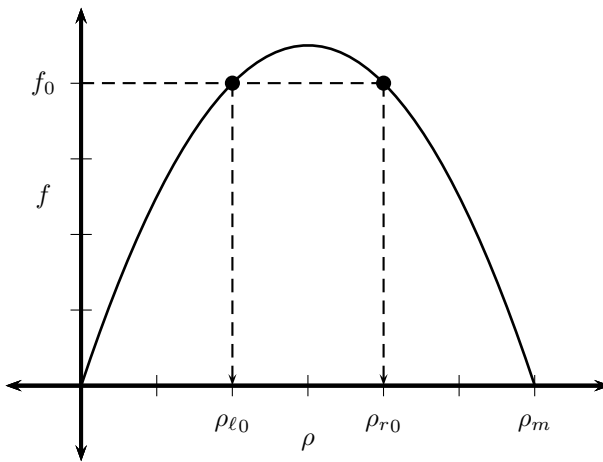

Figure 6: Two Densities for the Given Traffic Flow

Hence, for the same fixed steady state traffic flow given, there are two different travel times that are consistent with that data. They are given by Equation

18.

$$T(\rho_{\ell_0}) = \frac{\ell}{v_f(1 - \frac{\rho_{\ell_0}}{\rho_m})} \quad T(\rho_{r_0}) = \frac{\ell}{v_f(1 - \frac{\rho_{r_0}}{\rho_m})} \quad (18)$$

Although the travel time given by the function based on traffic flows is single valued, but that function is not consistent with the theory that a vehicle with the speed $v(\rho)$ will traverse the link in time given by the ratio of the distance to the speed. Hence, the problem of estimating travel time or even performing traffic assignment based on flow based travel time functions is an ill-posed problem. The problem must provide density information.

3. Average Travel Time Delay and Queue Length per Signalized Intersection

Travel time delay due to a signalized intersection can be calculated using Webster's formula ([23] and [21]). We will use Webster's uniform delay model since our problem statement deals with steady state conditions. This delay model is derived by considering the cumulative inflow of vehicles at the intersection as well as the cumulative outflow at the intersection.

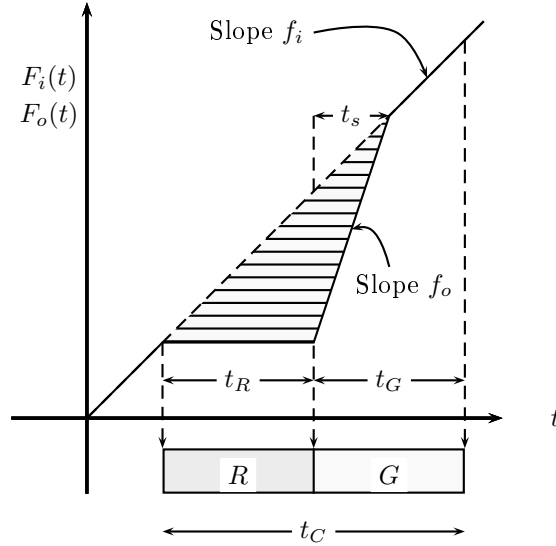

Figure 7: Queuing at an Intersection

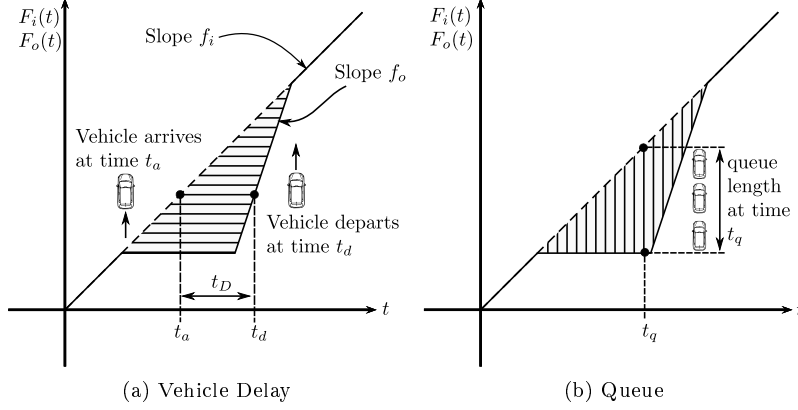

Figure 8: Vehicle Delay and Queue Formation at an Intersection

The variables used in the analysis are shown in Table 2.

Figure 7 shows all these parameters, where the straight line plot of $F_i(t)$ is shown for a cycle, as well as the piecewise linear plot of $F_o(t)$ is shown. The relationship between the cumulative flows and the flows are shown in Equation 19.

$$\frac{dF_i(t)}{dt} = f_i$$

$$\frac{dF_o(t)}{dt} = \begin{cases} 0, & \text{during red phase} \\ f_o, & \text{during saturation flow phase} \\ f_i, & \text{otherwise} \end{cases} \quad (19)$$

Figure 8a shows the arrival time for a vehicle obtained from the $F_i(t_a)$. The departure time for the same vehicle satisfies

$$F_i(t_a) = F_o(t_d) \quad (20)$$

Moreover, the delay time for the vehicle is given by $t_D = t_d - t_a$. Figure 8b shows the queue length at some time t_q . Queue length is given by $q(t) = F_i(t) - F_o(t)$.

The number of vehicle arriving during one full cycle is $f_i t_C$. The aggregate delay for all these vehicles is the area of the triangle. The area of the triangle divided by the number of vehicles during a cycle is the average vehicle delay. By exploiting the equality $f_i(t_R + t_s) = f_o t_s$ we derive the average delay as

$$t_{aD} = \frac{t_R^2}{2t_C} \frac{f_o}{f_o - f_i} \quad (21)$$

We can also obtain the average queue length as follows. This averaging will be over time as compared to the averaging over the number of vehicles that was

Table 2: Intersection Delay Parameters

| Parameter | Meaning |
|-----------|---|
| f_i | Rate of inflow at intersection |
| f_o | Rate of outflow from intersection |
| $F_i(t)$ | Cumulative inflow at intersection |
| $F_o(t)$ | Cumulative outflow at intersection |
| t_C | Cycle time |
| t_R | Red Time |
| t_G | Green Time |
| t_s | Saturated Flow Time |
| t_a | Time of arrival for a vehicle |
| t_d | Time of departure for a vehicle |
| t_D | Delay time for a vehicle ($t_D = t_d - t_a$) |
| $q(t)$ | Queue length at time t ($q(t) = F_i(t) - F_o(t)$) |
| q_{av} | Average queue length per time at an intersection |
| t_{aD} | Average vehicle delay through an intersection |
| ℓ | Section length |

performed for the delay calculations. The average queue length is calculated by averaging over the cycle time as shown in Equation 22.

$$q_{av} = \frac{1}{t_C} \int_0^{t_C} (F_i(t) - F_o(t)) dt \quad (22)$$

This is the area of the triangle in Figure 7 divided by the cycle time. This area of the triangle is the same in Figure 8a and Figure 8a, and hence is obtained from Equation 23.

$$q_{av} = f_i t_{aD} \quad (23)$$

Substituting Equation 21 in Equation 23, we obtain the expression for the average queue length as

$$q_{av} = \frac{t_R^2}{2t_C} \frac{f_i f_o}{f_o - f_i} \quad (24)$$

3.1. Shock Based Average Travel Time Delay and Queue Length per Signalized Intersection

Figure 9 shows the shock analysis of the traffic density when the traffic light turns from green to red, and also from red to green. Before time $t = 0$ the traffic density is ρ_0 everywhere. At time $t = 0$ the signal at $x = 0$ turns red. We see immediately four wedge shaped regions emanating in positive time. The rightmost and the left most wedges have density ρ_0 and the other right one has

density zero, and the left one has the traffic jam density (the queue) ρ_m . The shock travels backwards with speed

$$s = -\frac{v_f \rho_0}{\rho_m - \rho_0} \left(1 - \frac{\rho_0}{\rho_m} \right) \quad (25)$$

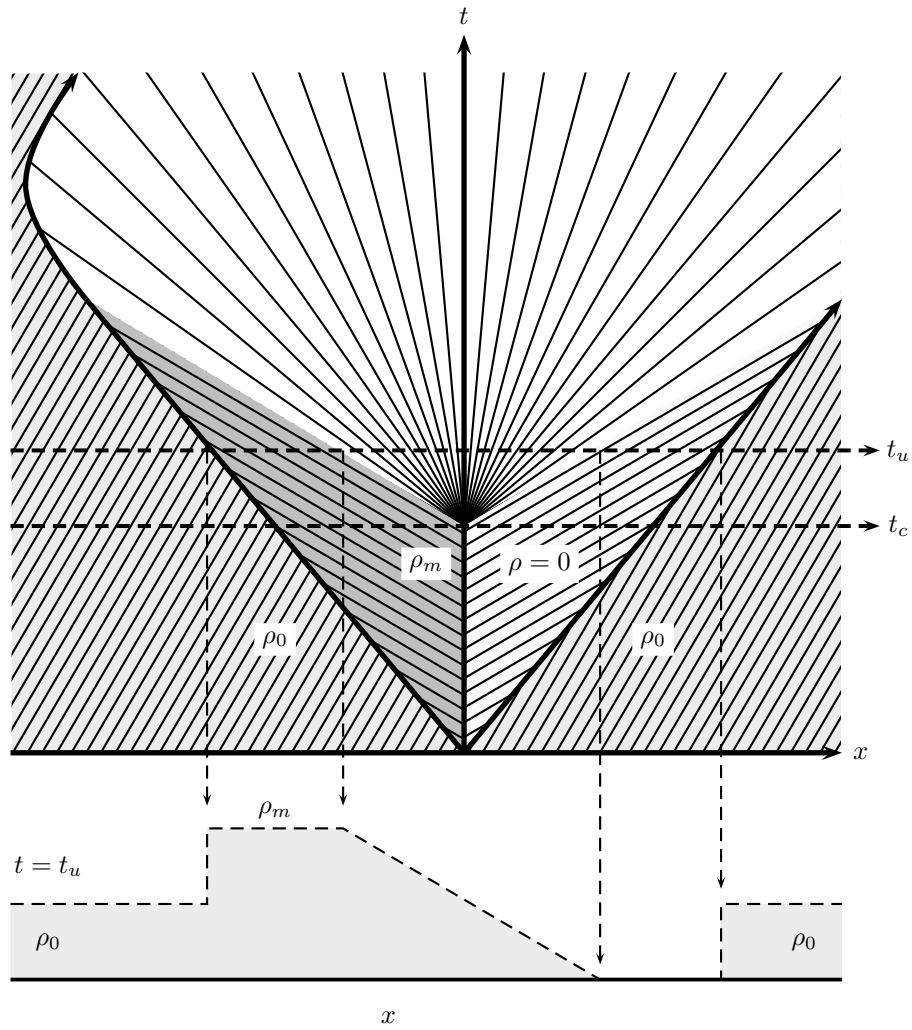

Figure 9: Traffic Characteristics

Figure 9 shows the red light being on till time $t = t_c$ at which time the light

turns green. The inflow is a constant flow given by

$$f_i = v_f \rho_0 \left(1 - \frac{\rho_0}{\rho_m} \right) \quad (26)$$

The outflow is zero during the red phase. During the green phase the outflow is at the saturation level, and is given by

$$f_o = \frac{1}{4} v_f \rho_m \quad (27)$$

The derivation of this saturation flow for this problem can be obtained from analysis ([11] and [20]).

Substituting Equation 26 and Equation 27 in Equation 25, the average travel time delay due the signalized intersection is obtained as

$$t_{aD} = \frac{t_R^2}{2t_C} \frac{\rho_m^2}{\rho_m^2 - 4\rho_m\rho_0 + \rho_0^2} \quad (28)$$

We can substitute Equation 26 and Equation 27 into Equation 24 to obtain the expression for the average queue length as

$$q_{av} = \frac{v_f t_R^2}{2t_C} \frac{\rho_0 \rho_m^2}{\rho_m^2 - 4\rho_m\rho_0 + \rho_0^2} \left(1 - \frac{\rho_0}{\rho_m} \right) \quad (29)$$

3.2. Travel Time Delay on a Link with Signalized Intersection at the End

In this subsection we calculate the average delay on a link that is terminated by a signalized intersection. Previously we calculated the travel time delay for a fixed length link, and also the average travel time delay through a signalized intersection. In order to calculate the average travel time through the link and the intersection, we need to calculate the travel time to reach the back end of the queue, and then the time to exit the front of the intersection. However, because of the queuing analysis using cumulative flows, the analysis becomes extremely simple as explained next.

If the link has green light all the time and is in steady state at density ρ_0 , then the inflow rate and the outflow rate are both same as shown in Figure 10a. In that case the travel time to cross the link of length ℓ is given in Equation 17 and repeated here for convenience.

$$T_u = \frac{\ell}{v_f \left(1 - \frac{\rho_0}{\rho_m} \right)} \quad (30)$$

where we have used the subscript u to indicate uninterrupted flow. When we add a signalized intersection of a cycle time t_C such that the maximum queue length is less than ℓ and moreover, the entire queue is dissipated within one cycle, then the additional time delay for an average vehicle is given in Equation 28 and repeated here for convenience.

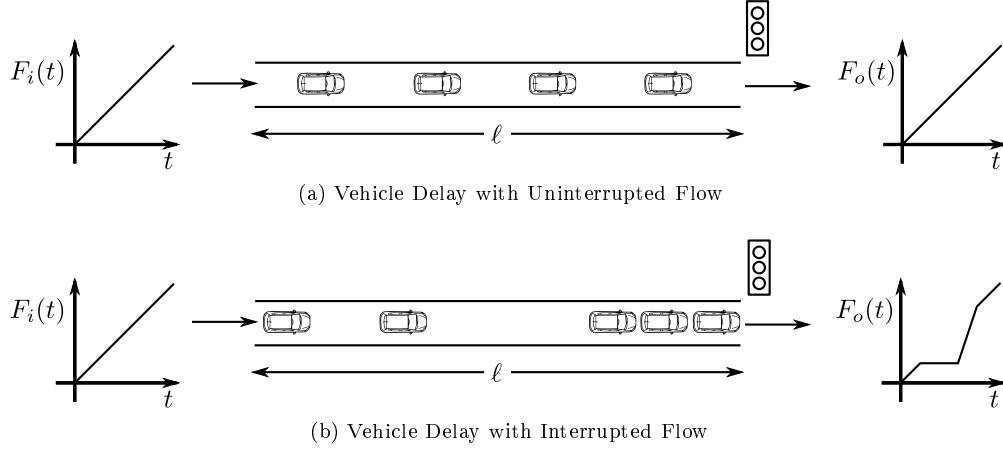

Figure 10: Total Vehicle Delay

$$t_{aD} = \frac{t_R^2}{2t_C} \frac{\rho_m^2}{\rho_m^2 - 4\rho_m\rho_0 + \rho_0^2} \quad (31)$$

Hence, the total average travel time on a link is

$$T = \frac{\ell}{v_f(1 - \frac{\rho_0}{\rho_m})} + \frac{t_R^2}{2t_C} \frac{\rho_m^2}{\rho_m^2 - 4\rho_m\rho_0 + \rho_0^2} \quad (32)$$

Here, we are assuming that the density on the link remains constant in the steady state on all links. This is the assumption made for static traffic assignment as compared to the dynamic traffic assignment.

4. Static Traffic Assignment Problem Formulation using Density based Travel Time Function

In this section we now build the density based traffic assignment problem. As shown in Section 3, we can include all the signalized intersection on an arc, and then add the delay due to all the intersections on that arc on top of the link travel time to compute the overall travel time on an arc. Data on each arc can be represented by a list of parameters of the subcomponent arcs of that specific arc. Any subarc which is unsignalized will have its parameter data represented by (ℓ, v_f, ρ_m) , and any signalized will have its parameter data represented by $(\ell, v_f, \rho_m, t_C, t_R)$. So, as an example, on a single arc, its data can be represented by

$$\mathbf{a}_i = ((\ell_{i1}, v_{f_{i1}}, \rho_{m_{i1}}, t_{C_{i1}}, t_{R_{i1}}), (\ell_{i2}, v_{f_{i2}}, \rho_{m_{i2}}), \dots, (\ell_{i_n}, v_{f_{i_n}}, \rho_{m_{i_n}})) \quad (33)$$

To illustrate the steps, we again use the sample network of Figure 2 but we modify it with the new data that is needed to solve the density based problem. This is shown in Figure 11. The digraph shows four nodes and four arcs. Nodes 1 and 2 are again the origin nodes and node 4 is the destination node. Hence, just like in the previous sample network, we again have two O-D pairs: 1 – 4 and 2 – 4. The data and parameters required in the flow based assignment were O-D flow matrix, and capacity on each link. This information is replaced in the density based assignment as shown in Table 3. As we have seen that flow alone can not fix the travel speed for vehicles. By specifying an O-D matrix of traffic densities, we are able to specify flow as well automatically, since flow is a function of traffic density. Moreover, the travel time now can be computed using the vehicle speed formula based on the density, which, instead of the capacity, utilize the free flow speed, jam density, and the arc length parameters, as well as cycle time parameters for the signalized intersections. For the sake of simplification, from now on we will consider only the link travel time delay instead of also having the signalized intersection delay for the analysis.

Table 3: Replacement in the Density based Assignment

| Original | Replacement |
|--------------|--|
| Flow f | Density ρ |
| Capacity C | Arc Parameter List (ℓ, v_f, ρ_m) |

Density related additional notation needed for this section is shown in Table 4.

Table 4: Density Related Additional Network Notation

| | |
|------------------|--|
| ρ_a | Density on arc $a \in \mathfrak{A}$ |
| $f(\rho_a)$ | Flow corresponding to ρ_a |
| ρ_{ak}^{rs} | Density on arc a due to path $k \in \mathfrak{K}$ between O-D pair $r - s$ |
| $f_{O_{rs}}$ | O-D flow from r to s |
| n_I | Set of arcs entering node n |
| n_O | Set of arcs exiting node n |

4.1. Flow Balance at Nodes

Although the new formulation is in terms of density as is necessitated by the travel time being a direct function of density rather than flow, the traffic inflow and outflow have to balance at nodes. To study the impact of this on the corresponding density values in equilibrium we study some cases next.

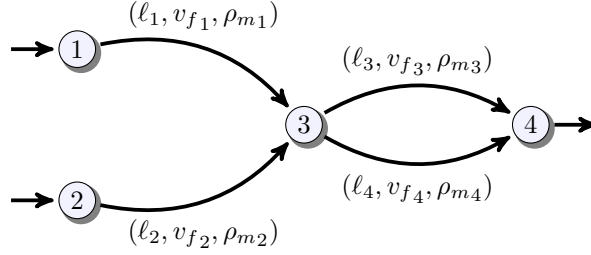

Figure 11: Sample Network with Density based Travel Time

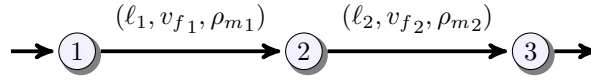

Figure 12: Flow Matching in Series

Consider a link having one inflow and one outflow as shown in Figure 12. The parameters of the two links are shown in the figure. The flow balance at the node forces the inflow to be equal to the outflow giving us the following equation.

$$v_{f_1} \rho_1 \left(1 - \frac{\rho_1}{\rho_{m_1}}\right) = v_{f_2} \rho_2 \left(1 - \frac{\rho_2}{\rho_{m_2}}\right) \quad (34)$$

Given the OD flow by f_{13} , there are two different values of density ρ_1 that will satisfy that given flow. For each of those two values, there will be two values of ρ_2 as well. Hence there will be four different solutions matching the exact same flow conditions. However, the four conditions will have different travel times. The minimum density in each arc will produce the minimum travel time solution. If there were two alternate routes, then we could have same travel times in two routes but not necessarily with lowest possible travel times in them unless we force that condition.

In the case of having more than one route passing through the same two links, we require the route balance conditions also to match. Let us denote $f_{1,3}$ as the flow from origin 1 to destination 3. Let us divide this flow into two routes, f_1^{13} and f_2^{13} , for $\{k = 1, 2\}$. We have the route flow conservation condition

$$\sum_k f_k^{13} = f_{13} \quad (35)$$

We use the notation f_{ak}^{rs} for the flow on the arc a corresponding to a route k of the origin destination pair rs . Now we can also define the density on an arc a corresponding to a route k of the origin destination pair rs using the corresponding flows as follows.

$$\rho_{ak}^{rs} = \frac{f_{ak}^{rs}}{f(\rho_a)} \rho_a \quad (36)$$

This proves easily that

$$f_k^{rs} = f_{ak}^{rs}, \text{ if } \delta_{ak}^{rs} = 1 \quad (37)$$

For every node in a network, the sum of all the inflow to the node must equal the sum of all the outflow from the node. For instance, the flow balance for node 3 in Figure 11 is as follows.

$$\sum_{i=1}^2 v_{f_i} \rho_i \left(1 - \frac{\rho_i}{\rho_{m_i}}\right) = \sum_{i=3}^4 v_{f_i} \rho_i \left(1 - \frac{\rho_i}{\rho_{m_i}}\right) \quad (38)$$

The node balance conditions also have conditions for balancing the route based flows similar to the case discussed above.

Now, we will consider the two main classical traffic assignment optimization problems as before. We will present the new density based formulations for the user-equilibrium and system optimum problems.

4.2. User-equilibrium

User-equilibrium problem is based on Wardrop's principle [28]. However now, travel time is computed based on vehicle speed formula based on traffic density.

We will present this equilibrium condition as a necessary condition for the solution of a modified mathematical programming problem and provide the proof of this assertion.

4.2.1. Mathematical Programming Formulation

Theorem 4.1. *The user equilibrium problem is equivalent to the mathematical programming problem presented in Equation 39.*

$$\min z(f_k^{rs}, \rho_a) = \sum_a \int_0^{f_a(f_k^{rs})} t_a(\omega) d\omega \quad (39)$$

with the equality constraints:

$$\sum_k f_k^{rs} = f_{rs} \quad \forall r, s \quad (40)$$

$$f_a(f_k^{rs}) = \sum_r \sum_s \sum_k f_{ak}^{rs} \delta_{a,k}^{rs} \quad (41)$$

$$\sum_r \sum_s \sum_k f_{ak}^{rs} \delta_{a,k}^{rs} = v_{f_a} \rho_a \left(1 - \frac{\rho_a}{\rho_{m_a}}\right) \quad (42)$$

$$f_{ak}^{rs} = f_k^{rs} \delta_{a,k}^{rs} \quad (43)$$

$$\sum_i v_{f_i} \rho_i \left(1 - \frac{\rho_i}{\rho_{m_i}}\right) = \sum_o v_{f_o} \rho_o \left(1 - \frac{\rho_o}{\rho_{m_o}}\right), \quad \forall i \in n_I, o \in n_O, n \in \mathfrak{N} \quad (44)$$

and the inequality constraint

$$\rho_a \geq 0 \forall a, \quad f_k^{rs} \geq 0 \forall k, r, s \quad (45)$$

and

$$\rho_{m_a} \geq \rho_a \geq 0 \forall a \quad (46)$$

The travel time function on the link $t_a(\rho_a)$ is a function of traffic density on the link and the link parameters as given by Equation 47.

$$t_a(\rho_a) = \frac{\ell_a}{v_{f_a} \left(1 - \frac{\rho_a}{\rho_{m_a}}\right)} \quad (47)$$

□

Note that we can incorporate a different density based function that also takes into account the signalized and unsignalized intersection delays. We have already shown the formula for the signalized intersection delay, and we can also develop a queuing theory based formula for the unsignalized intersection delay.

Proof. The Kuhn-Tucker conditions for the mathematical programming problem given by Equation 39 can be obtained in terms of the Lagrangian given in Equation 48.

$$\begin{aligned} \mathcal{L}(f, \rho, \lambda, \mu) = & z[f_k^{rs}, \rho_a] + \sum_{rs} \lambda_{rs} \left(f_{rs} - \sum_k f_k^{rs} \right) + \\ & \sum_a \mu_a \left(\sum_r \sum_s \sum_k f_k^{rs} \delta_{a,k}^{rs} - v_{f_a} \rho_a \left(1 - \frac{\rho_a}{\rho_{m_a}}\right) \right) + \\ & \sum_n \gamma_n \left(\sum_i v_{f_i} \rho_i \left(1 - \frac{\rho_i}{\rho_{m_i}}\right) - \sum_o v_{f_o} \rho_o \left(1 - \frac{\rho_o}{\rho_{m_o}}\right) \right) \quad (48) \end{aligned}$$

Here, λ_{rs} and μ_a are the Lagrangian multipliers. The relevant Kuhn-Tucker conditions $\forall k, r, s, a$ are:

$$\begin{aligned} f_k^{rs} \frac{\partial \mathcal{L}(f, \rho, \lambda, \mu)}{\partial f_k^{rs}} = 0, \quad \frac{\partial \mathcal{L}(f, \rho, \lambda, \mu)}{\partial f_k^{rs}} \geq 0 \\ \frac{\partial \mathcal{L}(f, \rho, \lambda, \mu)}{\partial \lambda_{rs}} = 0, \quad \frac{\partial \mathcal{L}(f, \rho, \lambda, \mu)}{\partial \mu_a} = 0 \quad (49) \end{aligned}$$

Applying these necessary conditions 49 to the mathematical program 39 we obtain the Wardrop conditions $\forall k, r, s$ as:

$$\begin{aligned} f_k^{rs}(c_k^{rs} - u_{rs}) &= 0, & c_k^{rs} - u_{rs} &\geq 0 \\ \sum_k f_k^{rs} &= f_{rs}, & f_k^{rs} &\geq 0 \end{aligned} \quad (50)$$

□

Because of inverse function theorem, each solution has a local injective mapping from density to flow except where $\partial f / \partial \rho = 0$. Hence locally we can consider the travel time to be a function of flow. We derive the local formula for travel time as a function flow next.

Traffic flow on an arc is a quadratic function of traffic density given by

$$f_a(\rho) = v_f \rho_a \left(1 - \frac{\rho_a}{\rho_m}\right) \quad (51)$$

The maximum flow f_m using the Greenshield formula is obtained at $\rho_m/2$ and is given by

$$f_m = \frac{v_f \rho_m}{4} \quad (52)$$

We can solve for ρ_a in terms of f_a by solving the quadratic equation

$$\frac{v_f}{\rho_m} \rho_a^2 - v_f \rho_a + f_a = 0 \quad (53)$$

to yield, after using Equation 52 here,

$$\rho_a(f_a) = \frac{\rho_m}{2} \left(1 \pm \sqrt{1 - \frac{f_a}{f_m}}\right) \quad (54)$$

The travel time function can also be written in terms of the traffic flow locally (where $\partial f / \partial \rho \neq 0$) by utilizing Equation 54 as

$$t_a = \frac{\ell_a}{v_{f_a} \left(1 - \frac{\rho_a}{\rho_{m_a}}\right)} = \frac{\ell_a \rho_a}{f_a} = \frac{\ell_a \rho_m}{f_a} \frac{1}{2} \left(1 \pm \sqrt{1 - \frac{f_a}{f_m}}\right) \quad (55)$$

We can rewrite this relationship as

$$t_a(x) = \frac{k}{x} (1 \pm \sqrt{1-x}), \quad \text{with } x = \frac{f_a}{f_m}, \quad \text{and } k = \frac{\ell_a \rho_m}{2 f_m} \quad (56)$$

Differentiating Equation 56 we obtain

$$\frac{t_a(x(f_a))}{df_a} = \frac{t_a(x(f_a))}{dx} \frac{dx}{df_a} = \left[-\frac{1}{x^2} \pm \left(\frac{1}{2\sqrt{1-x}} + \frac{\sqrt{1-x}}{x^2} \right) \right] \frac{1}{f_m} \quad (57)$$

The plots of Equations 56 for travel time as functions of flow and of its derivative in Equations 57 are shown in Figure 13. The plots are drawn just to show the shapes of the curve and the signs. These plots are not in true scale. The subfigure (a) shows the plot for the negative sign in Equation 56, plot (b) being its derivative. The subfigure (c) shows the plot for the positive sign in Equation 56, plot (d) being its derivative. The derivative has a positive sign in subfigure (b) as compared to the sign in subfigure (d).

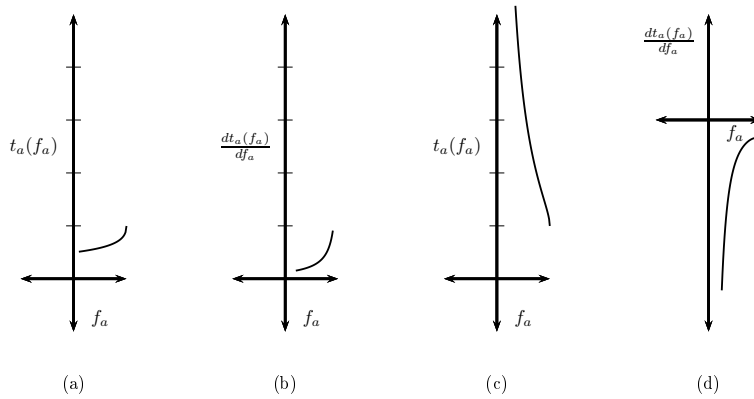

Figure 13: Travel Time and Derivatives Plots

The Hessian matrix with respect to arc flows f_a related to Equation 39 is a diagonal matrix with diagonal terms being the derivatives in Equation 57. This shows that in terms of arc flows there is a unique solution for the arc flows for the user equilibrium problem which is obtained at flows corresponding to the uncongested densities, i.e. densities lower than the critical densities, i.e. densities leading to maximum flow. What this analysis shows is that the minimizing problem has a unique solution in terms of the arc flows and arc densities. However, the solution in terms of path flows and consequently densities on arcs that are assigned to various paths are not unique (see [24]).

Hence, we see that the density based travel time function retains the Wardrop condition as a necessary condition after modifying the mathematical programming problem to accomplish that. As we can see here though that with the density based travel time formulation we get a stronger result for the Beckman formulation. We obtain the unique arc densities also for the solution of the Beckman formulation which we don't get by just solving the Wardrop condition.

4.3. System Optimal Solution

In this section we show how the system optimal solution can also be obtained as a solution of a new mathematical programming problem using the density

based travel time function.

4.3.1. Mathematical Programming Formulation

Theorem 4.2. *The system optimal problem is equivalent to the mathematical programming problem presented in Equation 58.*

$$\min z(f_k^{rs}, \rho_a) = \sum_a f(f_k^{rs}) t_a(\rho_a) \quad (58)$$

with the equality constraints:

$$\sum_k f_k^{rs} = f_{rs} \quad \forall r, s \quad (59)$$

$$f(f_k^{rs}) = \sum_r \sum_s \sum_k f_{ak}^{rs} \delta_{a,k}^{rs} \quad (60)$$

$$\sum_r \sum_s \sum_k f_{ak}^{rs} \delta_{a,k}^{rs} = v_{f_a} \rho_a \left(1 - \frac{\rho_a}{\rho_{m_a}}\right) \quad (61)$$

$$f_{ak}^{rs} = f_k^{rs} \delta_{a,k}^{rs} \quad (62)$$

$$\sum_i v_{f_i} \rho_i \left(1 - \frac{\rho_i}{\rho_{m_i}}\right) = \sum_o v_{f_o} \rho_o \left(1 - \frac{\rho_o}{\rho_{m_o}}\right), \quad \forall i \in n_I, o \in n_O, n \in \mathfrak{N} \quad (63)$$

and the inequality constraint

$$\rho_a \geq 0 \quad \forall a, \quad f_k^{rs} \geq 0 \quad \forall k, r, s \quad (64)$$

and

$$\rho_{m_a} \geq \rho_a \geq 0 \quad \forall a \quad (65)$$

The travel time function on the link $t_a(\rho_a)$ is given by Equation 47. \square

Proof. The Kuhn-Tucker conditions for the mathematical programming problem given by Equation 58 can be obtained in terms of the Lagrangian given in Equation 66.

$$\begin{aligned} \mathfrak{L}(f, \rho, \lambda, \mu) = & z[f_k^{rs}, \rho_a] + \sum_{rs} \lambda_{rs} \left(f_{rs} - \sum_k f_k^{rs} \right) + \\ & \sum_a \mu_a \left(\sum_r \sum_s \sum_k f_{ak}^{rs} \delta_{a,k}^{rs} - v_{f_a} \rho_a \left(1 - \frac{\rho_a}{\rho_{m_a}}\right) \right) + \\ & \sum_n \gamma_n \left(\sum_i v_{f_i} \rho_i \left(1 - \frac{\rho_i}{\rho_{m_i}}\right) - \sum_o v_{f_o} \rho_o \left(1 - \frac{\rho_o}{\rho_{m_o}}\right) \right) \quad (66) \end{aligned}$$

Here, λ_{rs} and μ_a are the Lagrangian multipliers. The relevant Kuhn-Tucker conditions $\forall k, r, s, a$ are:

$$\begin{aligned} f_k^{rs} \frac{\partial \mathcal{L}(f, \rho, \lambda, \mu)}{\partial f_k^{rs}} &= 0, & \frac{\partial \mathcal{L}(f, \rho, \lambda, \mu)}{\partial f_k^{rs}} &\geq 0 \\ \frac{\partial \mathcal{L}(f, \rho, \lambda, \mu)}{\partial \lambda_{rs}} &= 0, & \frac{\partial \mathcal{L}(f, \rho, \lambda, \mu)}{\partial \mu_a} &= 0 \end{aligned} \quad (67)$$

Applying Kuhn-Tucker conditions in this case we get $\forall k, r, s$:

$$\begin{aligned} f_k^{rs} (\tilde{c}_k^{rs} - \tilde{u}_{rs}) &= 0, & \tilde{c}_k^{rs} - \tilde{u}_{rs} &\geq 0 \\ \sum_k f_k^{rs} &= f_{rs}, & f_k^{rs} &\geq 0 \end{aligned} \quad (68)$$

Here, we have

$$\tilde{c}_k^{rs} = \sum_a \delta_{a,k}^{rs} \tilde{t}_a \quad (69)$$

where

$$\tilde{t}_a(\rho_a) = t_a(\rho_a) + f(\rho_a) \frac{dt_a(\rho_a)}{df(\rho_a)} \quad (70)$$

□

The differentiation of the travel time function with respect to the traffic arc flow is the same as shown in Equation 57, which is valid because of the application of the inverse function theorem as was the case for the user equilibrium analysis.

5. Conclusions

This paper presented a traffic density based travel time function as compared to flow based one. This makes the traffic assignment problem framework consistent with the macroscopic and microscopic aspects of traffic theory. Travel time function that includes urban networks with signalized intersections was also developed. The paper then re-derived the formulation of static traffic assignment problems using the new travel time function, and also obtained their relationship to Wardrop condition for user equilibrium and marginal travel time equivalent for the system optimum problem. The paper showed that the Beckman formulation provides a unique solution for arc flows as well as arc densities, whereas the Wardrop condition alone has multiple arc density solutions.

6. Acknowledgement

The work performed in this research was partially supported by Lincy Professorship, UNLV development leave and an NSF grant.

- [1] Rahmi Akçelik. Travel time functions for transport planning purposes: Davidson's function, its time dependent form and alternative travel time function. *Australian Road Research*, 21(3), 1991.
- [2] Sanghoon Bae and Pushkin Kachroo. Proactive travel time predictions under interrupted flow condition. In *Vehicle Navigation and Information Systems Conference, 1995. Proceedings. In conjunction with the Pacific Rim TransTech Conference. 6th International VNIS. 'A Ride into the Future'*, pages 179–186. IEEE, 1995.
- [3] M.J. Beckmann, C.B. McGuire, and C.B. Winsten. Studies in the economics of transportation. 1955.
- [4] David Branston. Link capacity functions: A review. *Transportation Research*, 10(4):223–236, 1976.
- [5] Stella. C. Dafermos and F.T. Sparrow. The traffic assignment problem for a general network. *J. of Res. of the National Bureau of Standards*, 73B:91–118, 1969.
- [6] Carlos F Daganzo. The cell transmission model: A dynamic representation of highway traffic consistent with the hydrodynamic theory. *Transportation Research Part B: Methodological*, 28(4):269–287, 1994.
- [7] Matthew P D'Angelo, Haitham M Al-Deek, and Morgan C Wang. Travel-time prediction for freeway corridors. *Transportation Research Record: Journal of the Transportation Research Board*, 1676(1):184–191, 1999.
- [8] KB Davidson. A flow travel time relationship for use in transportation planning. In *Australian Road Research Board (ARRB) Conference, 3rd, 1966, Sydney*, volume 3, 1966.
- [9] H. Greenberg. An analysis of traffic flow. *Operational Research*, 7:78–85, 1959.
- [10] B. D. Greenshields. A study in highway capacity. *Highway Research Board*, 14:458, 1935.
- [11] R. Haberman. *Mathematical Models*. Prentice-Hall, New Jersey, 1977.
- [12] Wacław Jastrzebski. Volume delay functions. In *15th International EMME/2 Users Group Conference*, 2000.
- [13] P. Kachroo and K. Ozaby. Solution to the user equilibrium dynamic traffic routing problem using feedback linearization. *Transp. Res. B.*, 32(5):343–366, 1998.
- [14] P. Kachroo and K. Özbay. Modeling of network level system-optimal real-time dynamic traffic routing problem using nonlinear h_∞ feedback control theoretic approach. *Journal of Intelligent Transportation Systems*, 10(4):159–171, 2006.

- [15] Pushkin Kachroo and Kaan Ozbay. *Feedback Control Theory For Dynamic Traffic Assignment*. Springer-Verlag, 1999.
- [16] Pushkin Kachroo and Kaan Ozbay. Feedback control solutions to network level user-equilibrium real-time dynamic traffic assignment problems. *Networks and Spatial Economics*, 5(3):243–260, September 2005.
- [17] Pushkin Kachroo, Kaan Ozbay, and Antoine G Hobeika. Real-time travel time estimation using macroscopic traffic flow models. IEEE ITSC Conference, 2001.
- [18] Pushkin Kachroo and Neveen Shlayan. Dynamic traffic assignment: A survey of mathematical models and techniques. In *Advances in Dynamic Network Modeling in Complex Transportation Systems*, pages 1–25. Springer, 2013.
- [19] Jaimyoung Kwon, Benjamin Coifman, and Peter Bickel. Day-to-day travel-time trends and travel-time prediction from loop-detector data. *Transportation Research Record: Journal of the Transportation Research Board*, 1717(1):120–129, 2000.
- [20] R. J. Leveque. *Numerical Methods for Conservation Laws*. Birkh"auser, 1992.
- [21] Highway Capacity Manual. Highway capacity manual, 2000.
- [22] Sungkwon Kang Pushkin Kachroo, Kaan Ozbay and John A. Burns. System dynamics and feedback control formulations for real time dynamic traffic routing. *Mathl. Comput. Modelling*, 27(9-11):27–49, 1998.
- [23] Roger P Roess, Elena S Prassas, and William R McShane. *Traffic engineering*. Prentice Hall, 2004.
- [24] Yosef Sheffi. *Urban Transportation Networks:Equilibrium Analysis with Mathematical Programming Methods*. Prentice-Hall, 1985.
- [25] Heinz Spiess. Technical noteãconical volume-delay functions. *Transportation Science*, 24(2):153–158, 1990.
- [26] Shawn M Turner, William L Eisele, Robert J Benz, and Douglas J Holdener. Travel time data collection handbook. Technical report, 1998.
- [27] R. T. Underwood. Speed, volume, and density relationships: Quality and theory of traffic flow. *Yale Bureau of Highway Traffic*, pages 141–188, 1961.
- [28] J.G. Wardrop. Some theoretical aspects of road traffic research. *Proceedings, Institute of Civil Engineers, PART II*, 1:325–378, 1952.